



# Development and FE Analysis of Reinforced Composites for car Bumper: A Review

S. Seenivasan<sup>1\*</sup>, R. Chandraprakash<sup>2</sup>, P. Raj Kumar<sup>3</sup>,  
N. Dineshkumar<sup>4</sup>, R. Kathiravan<sup>5</sup>

## Abstract

The current technological advances give us a chance to find and fabricate the brand new materials to restore existing material. Also, the necessary for environmental friendly, easily decomposable material plays a vital role in determining the raw material. In this paper flax fiber and kenaf fiber with the filler material aluminium hydroxide were used as suspending matrix to form a hybrid composite with vinyl VBR resin and epoxy resin. The hand layup technique is carried out to fabricate the composite. In this journal we conducted the several tests to analyze the mechanical properties and thermal properties of the composite material. The basic car bumper is designed and the static analysis is done on the ansys workbench for the results of total deformation, stress and strain energy.

**Key Words:** Kenaf, Flax, Aluminium hydroxide, Properties of flax-kenaf fiber, total deformation, stress and strain energy  
**DOI Number:** 10.14704/nq.2022.20.8.NQ44713 **NeuroQuantology 2022; 20(8):6868-6873**

## Introduction

Natural fiber crops are some of the oldest cultivated plants. The new polymer due to the searching for suitable technology for the global availability of natural fiber and other highly accessible agro waste [1, 2]

Company to existing fiberglass reinforced polymers composite. The natural fibers we introduced to form lighter compound at low cost in second days the automative. Spots and leisure constructions and other mass production induces all stays the focus on sustainable and renewable reinforced composites. This interest changes some shapes and materials from synthetic to natural. The compounding of reinforcements such as filler and fiber into compounds over the way for improve the properties of compounds that gets our requirement of most engineer application[3].As a result the demand for the natural reinforced composites increase due to lower product cost and lower resin consumption and various applications in the sections in the

scientific research paper the overall properties, 6868  
Mechanical properties, thermal properties and water absorption properties of flax-kenaf reinforced composite will be previewed and in future researches the key technical issues are solved[4].

## Fibers

Fibers are formed in the shape of fiber from the plants or animals is called as natural fibers. There are six types of natural fibers. Some of the types are, bast fiber, leaf fiber, seed fiber, core fiber, grass fiber, reed fiber [5,6].

## Kenaf Fibre

Kenaf belongs to the genus Malvaceae. It is one of the composite fibers of hemp and shows similar properties. It is a high-yielding tropical plant. It is grown traditionally for its long and strong bast fibers that form in the bark layers of the stem[7,10].

**Corresponding author:** S. Seenivasan

**Address:** <sup>1</sup>Associate Professor, Department of Mechanical Engineering, Dhaanish Ahmed Institute of Technology, Coimbatre-641105, Tamilnadu, India, <sup>2,3,4</sup>Assistant Professor, Department of Mechanical Engineering, Dhaanish Ahmed Institute of Technology, Coimbatre-641105, Tamilnadu, India, <sup>5</sup>Assistant Professor, Department of Mechanical Engineering, Karpagam Institute of Technology, Coimbatre-641105, Tamilnadu, India  
E-mail: seenikct@gmail.com



**Flax fiber**

Flax belongs to the genus Linnaceae. It is an erect annual plant grow up to 1.2 m tall with slender

stems and is take out from the stem of the flax plant. It is higher strength than cotton fiber but less elastic[8,9].

**Properties of Kenaf & Flax**

Properties	Flax Fiber	Kenaf Fiber
Density Kg/m3	1500	1320
Tensile Strength Mpa	345	260
Moist absorption[%]	10-11	10-12

**Properties of Fiber Reinforced Composite**

**Water Absorption**

Water absorption of a substance involves the water absorbed at the surface and also involves the water absorbed by the body of the material during preparation and material service [11,12,13]. Poly (methyl methacrylate) absorbs water because the polarity of the water molecule and the intermediate chain in the polymer is smaller than the distance[14]. The degree of water absorption of a polymeric material is determined by the polymer structure, the content of the various polar and hydrophilic groups in the polymer structure, the temperature, the concentration of various compounds, the vacuums in the matrix, the physical and chemical properties that can be affected by the absorbed water [15,16].

depends on the type of polymer and the reinforcement[21]. The fracture hardness of mono methacrylate-based material is lower than that of de methacrylate-based material. In general, storing "internal" body aging and/or high temperatures in humid environments can reduce fracture stiffness and other mechanical properties. However, fracture stiffness can be increased by adding reinforcing fibers in the polymer to prevent or reduce the growth of cracks[22].Linear coefficient of thermal expansion: The variation of the coefficient of thermal expansion between different materials is important because incompatibility can occur. Strains, resulting in the formation of stress and adverse effects on the interface[23]. Therefore, heat-induced strains and stresses adversely affect the long-term stability of the intrinsic material. By adding fibers to the polymer, the coefficient of thermal expansion decreases. In general, the heat coefficient varies depending on the direction of the fibers. One of the major concerns in the development of dental products is physical and chemical life.

6869

**Flexure Strength**

These substances are often tested in the laboratory, although the method of failure and many other characteristics affect clinical performance[17]. Researchers emphasize the importance of fatigue and fracture severity in predicting the clinical efficacy of many different types of teeth. Ingredients include fiber compounds. It should be noted that the test methods, the procedures for preparing the samples, and, in particular, the geometry of the test specimens all affect the calculated flexural strength[18,19]. The flexibility of strength-processed fiber-reinforced composites for commercial laboratory may be approximately 300 to 1,000 MPa depending on sample preparation and geometry[20].

**Fabrication of Composite**

The experimental setup requires materials such as die, flax and kenaf fibers, vinyl VBR resin, hardener for resin and aluminum foil, beaker, brush and wax for easy removal, The first step is to mix the resin and the hardener along with the filler material[1,10]. While making the composite, after cleaning the die we apply a good amount of wax to each and every part of die, wax is applying to the die in order to prevent the sticking of material in the die.After applying wax, the next step is to cover both male and female side of die with aluminium foil.According to the composition properly cut (long fiber) and measure both flax-kenaf fiber.Take a beaker, and pour the Resin until it weights 110g and add 10g of appropriate hardner for the resin.Add the filler material at the exact weight by measuring and pour it in the beaker which contains the resin and hardner and mix it untill heat discharge occurs.In

**Fracture Toughness**

The fracture stiffness of an object represents the resistance to fracture of an object and refers to the energy required to propagate the fracture through the material to complete the fracture[5]. The breakdown hardness of polymer composites



die, place fiber in a sandwich manner like pour the resin which contains the filler material in to the die and on the above, place one of the fiber and pour the resin above the fiber as same, place the another fiber and the pour the balance resin on it, all fiber should be placed in a manner in the die as it will not be out of the area of die. After closing the die, place it in the compression moulding machine for about 90 minutes applying 50 ton of pressure along with heat. After 90 minutes of time leave the die for about 120 minutes to cool down and after the time, we can remove the composite plate from the die[25]

**Result and Discussion**

In making of the natural fiber composite, we used vinyl VBR resin to bond fibers, but the bonding of vinyl VBR in long fiber composite plate is very weak & not bonded. Because of the weak bond formation in natural fiber composite plate. We used another resin and continue the experiment .As we already discussed due to failure in experiment due to the weak bonding of vinyl VBR resin in natural fiber composite plate. We added epoxy resin. By using epoxy resin, there was a strong bond formation in a short time comparing to the consumed by vinyl VBR in compression moulding machine



**Unbounded Natural Composite**



**Bonded Natural Composite**

**Properties Of Kenaf & Flax**

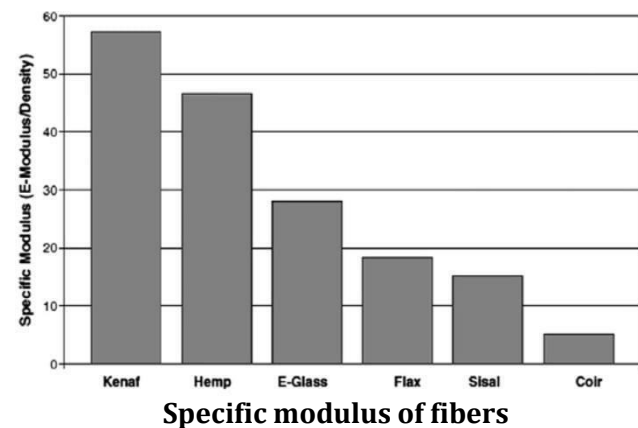
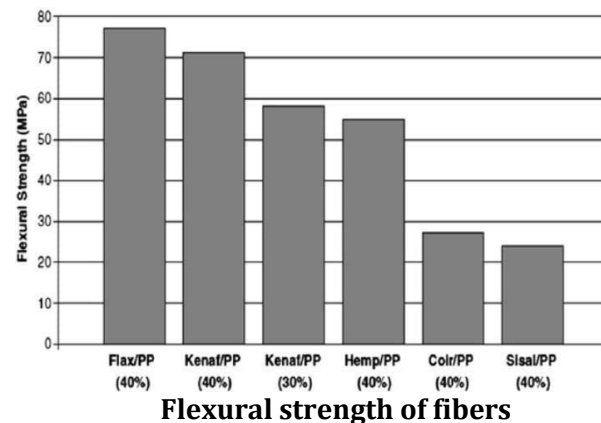
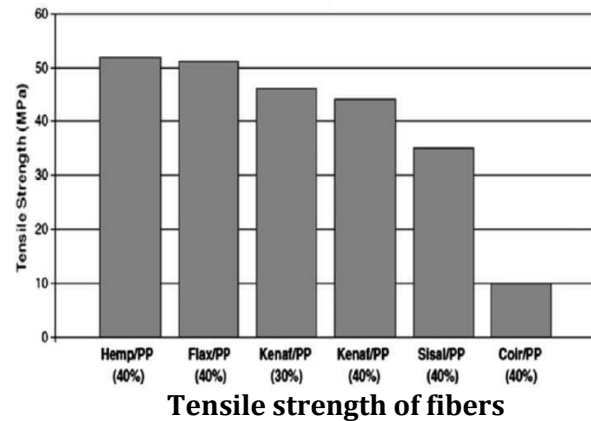

**Design of Basic Car Bumper**

Modeling of a automobile bumper is completed with the help of 3D modeling software system Auto cad. The dimensions are in millimeter(mm)[25,26].



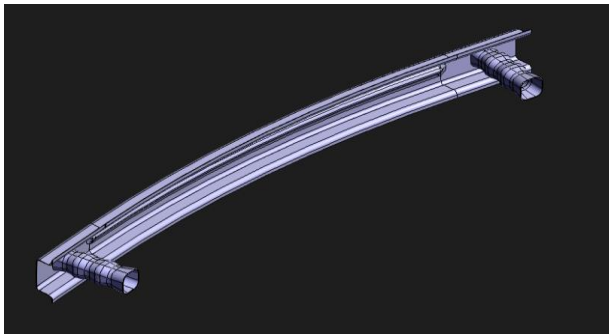
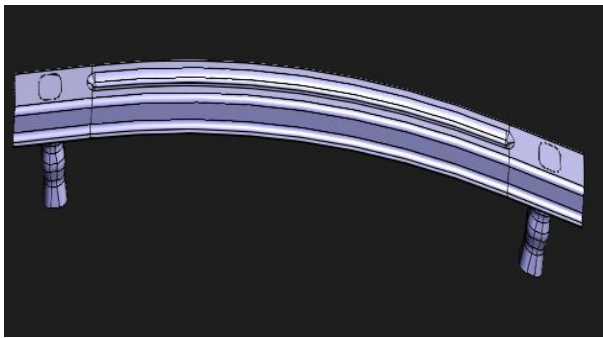

Isometric view of basic car bumper

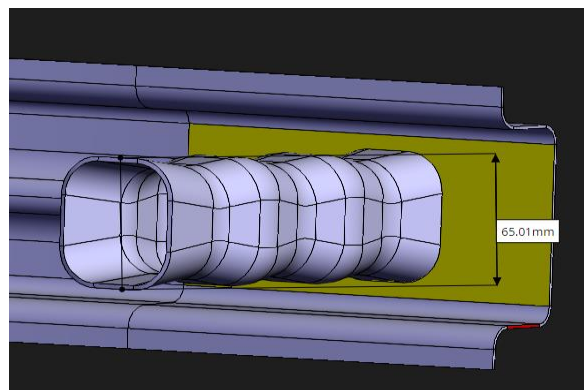
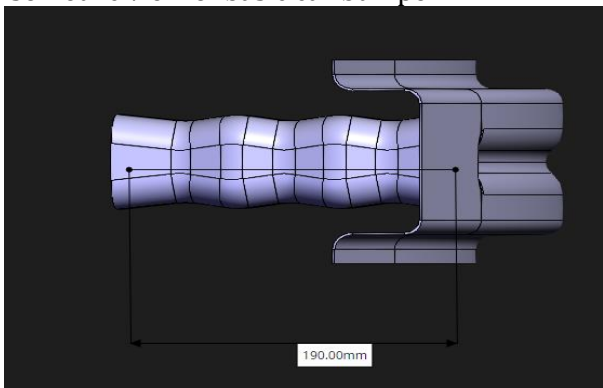

Side view of basic car bumper

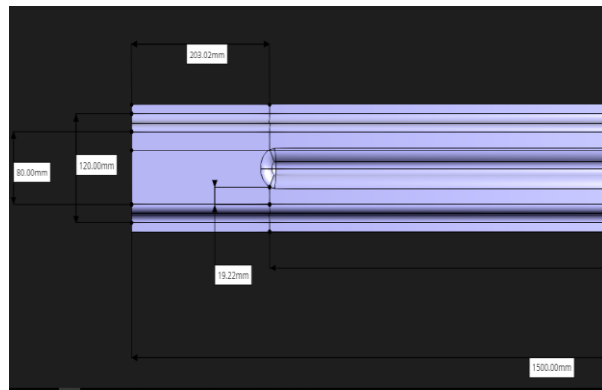
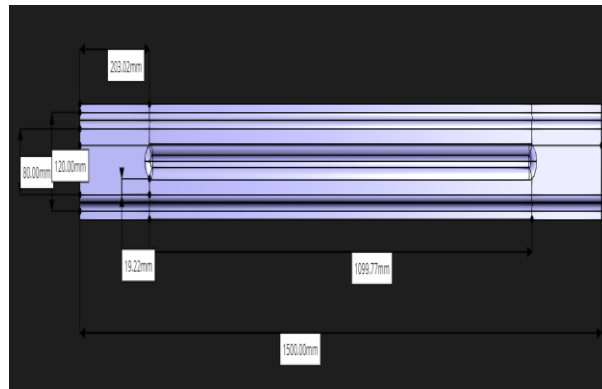

Front view of basic car bumper

### Static Analysis of Basic Car Bumper

6871

#### Static Analysis of Basic Car Bumper with Structural Steel

The bumper model which imported was meshed the results of total deformation, stress and strain energy is analyzed with meshed geometry. As we know steel is known for its weight and rigid support is given to the vehicle, but it should absorb the energy as it is a bumper and for the passenger safety it should be still. The total deformation, stress and strain energy is analyzed in this method [26,27].

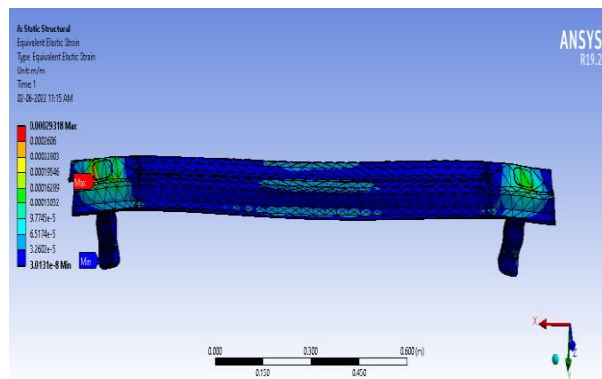

Equivalent elastic strain



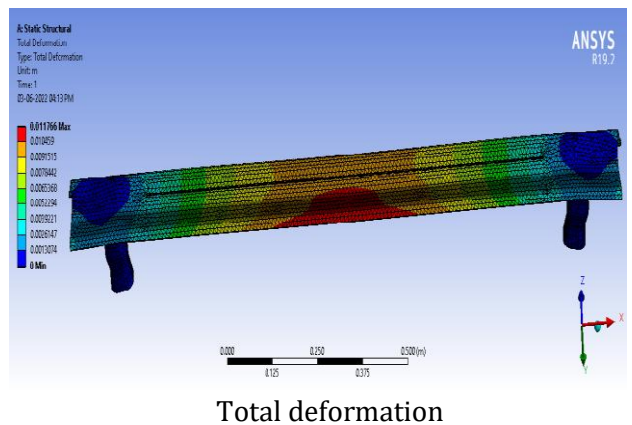
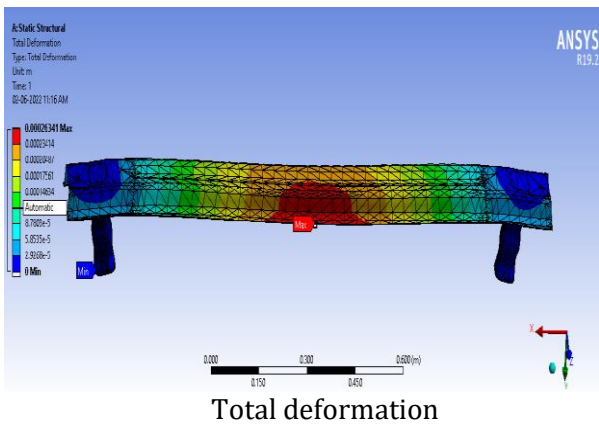
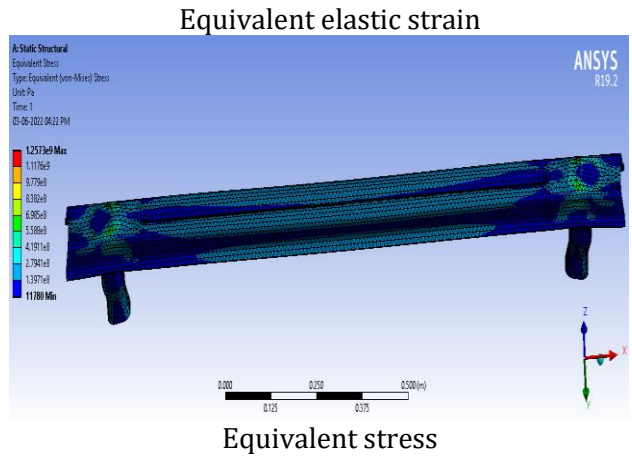
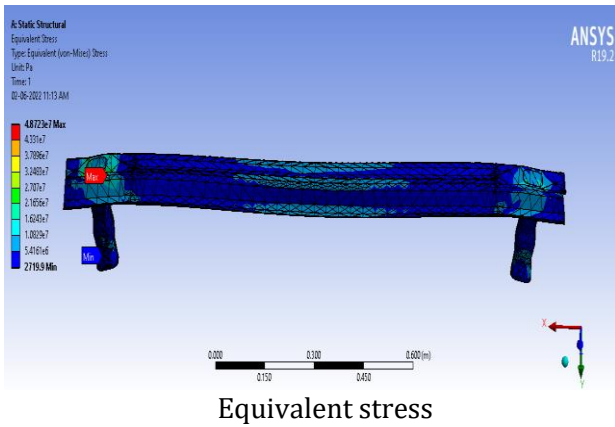

**Static Analysis of Basic Car Bumper with Composite Material Flax-Kenaf Fiber**

The dimensions are followed as same in the structural steel, the composite material flax-kenaf fiber has been changed by the study of material. The fuel economy plays a important role in the present condition of the competitive world. In order to achieve this method the researchers shift to the light weight bumper such as composite material flax-kenaf fiber[25]. The total deformation, stress and strain energy is analyzed by this by this method. The flax-kenaf fiber has advantages of the composite material of high strength to weight ratio[28].

**Conclusion**

Due to the excellent properties and environmental perception the research on the flax and kenaf reinforced composites are focused. In a previous study, an abstract is given with a review of the discussion of flax kenaf fiber reinforced compounds. The aim of the above topics are replace reinforcement in convectional material or the synthetic fiber composites with kenaf and flax fiber in an alternative method and also being the notice this in an scientists views. Many of the key properties of flax-kenaf fiber reinforced composite are studied and well documented in general the wide are of the flax-kenaf fiber reinforced composite will create an job opportunities to the urban and rural areas from the inside helps. We can contributes to a healthy environment by reducing waste and in industries and automobile sector. However, looking at future needs deep studies in the production are essential for commercial in action and production processes. Mainly for large scale termination products. [27-29]In the present condition the fuel economy plays a major role in the competitive world so in order to achieve this ,the

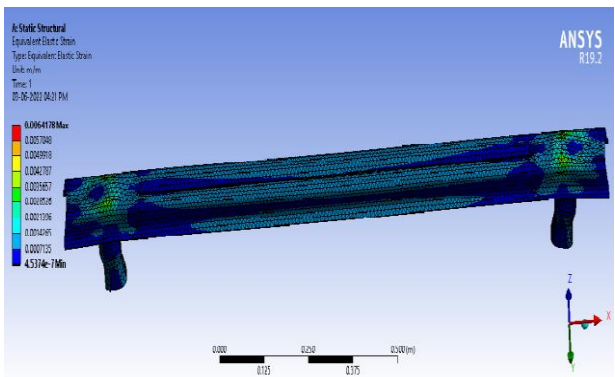

studies and researchers are turned to the light weight bumpers like composite material flax-kenaf fiber. The total deformation steels and strain energy analysis are done. The weight ratio in comparison with carbon fiber steel and dissipates energy. The high strength is given by the carbon fiber.

## Reference

- H.M. Akil ,M.F. Omar, A.A.M. Mazuki, S. Safiee, Z.A.M. Ishak, A. Abu Bakar, Kenaf fiber reinforced composites: A review. *Materials and Design* 32 (2011) 4107–4121. doi:10.1016/j.matdes.2011.04.008
- V.S. Srinivasan, S. Rajendra Boopathy, B. Vijaya Ramnath, Thermal Behaviour of Flax Kenaf Hybrid Natural Fiber Composite, ISSN: 2350-0328, Vol. 2, Issue 10 , October 2015
- V.S. Srinivasan, S. Rajendra Boopathy and B. Vijaya Ramnath, Investigation on Shear Behaviour of Flax-kenaf Hybrid Composite. *Advanced Materials Research* Vol. 1051 (2014) pp 139-142, doi:10.4028/www.scientific.net/AMR.1051.139
- Averous, L. and Boquillon, N. (2004). Biocomposites based on plasticized starch: thermal and mechanical behaviours, *Carbohydrate Polymers*, 56: 111-122
- Pothan LA, Oommen Z, Thomas S. Dynamic mechanical analysis of banana fiber reinforced polyester composites. *Compos Sci Technol* 2003;63:283–93
- Curvelo, A.A.S., de Carvalho, A.J.F. and Agnelli, J.A.M. (2001), Thermoplastic starch – cellulosic fibers composites: preliminary studies, *Carbohydrate Polymers*, 45(2): 183-188
- Kumar, R., Yakubu, M.K., and Anandjiwala, R.D. (2010), Biodegradation of flax reinforced poly lactic acid, *Express Polymer Letters*, Vol 4(7): 423-430
- Rowell RM, Sanadi A, Jacobson R, Caulfield D. Properties of kenaf/polypropylene composites. Kenaf properties, processing and products. Mississippi: Ag & Bio Engineering; 1999
- Libo Yan , Nawawi Chow , Krishnan Jayaraman. Flax fibre and its composites – A review. *Composites: Part B* 56 (2014) 296–317
- Nishino T, Hirao K, Kotera M, Nakamae K, Inagaki H. Kenaf reinforced biodegradable composite. *Compos Sci Technol* 2003;63:1281–6
- M. Abu Kassim, A. Crosky and D. Ruys, Water Absorption and Modification of Kenaf and Flax Fibres. *Advanced Materials Research*, 545(), 342–347. doi:10.4028/www.scientific.net/AMR.545.342
- Dhakal H, Zhang Z, Richardson M. Effect of water absorption on the mechanical properties of hemp fiber reinforced unsaturated polyester composites. *Compos Sci Technol* 2007;67:1674–83
- Akil HM, Cheng LW, Mohd Ishak Z, Abu Bakar A, Abd Rahman M. Water absorption study on pultruded jute fiber reinforced unsaturated polyester composites. *Compos Sci Technol* 2009; 69:1942–8.
- Chow C, Xing X, Li R. Moisture absorption studies of sisal fiber reinforced polypropylene composites. *Compos Sci Technol* 2007;67:306–13
- Aziz SH, Ansell MP. The effect of alkalization and fiber alignment on the mechanical and thermal properties of kenaf and hemp bast fiber composites: part 1-polyester resin matrix. *Compos Sci Technol* 2004;64:1219–30
- Ahmad Thirmizir, M.Z., Mohd Ishak, A.Z., Mat Taib, R., Rahim, S. and Mohamad Jani, S. (2011). Natural Weathering of kenaf bast fibre-filled poly (butylenes succinate) composites: Effect of Fibre Loading and Compatibiliser Addition, *Journal of Polymer Environment*, 19:263-273
- A. Mohamed Abdul Ajeez , T. Pushpaganeshan, Experimental Investigation On Mechanical Properties Of Flax Fiber Reinforced Composites With Epoxy. ISSN: 2321-9653; IC Value: 45.98; SJ Impact Factor:6.887 Volume 5 Issue VIII, August 2017
- Chow P, Lambert RJ, Bowers C, McKenzie N. Physical and mechanical properties of composite panels made from kenaf plant fibers and plastics;2000. p. 139–43
- Ochi S. Mechanical properties of kenaf fibers and kenaf/PLA composites. *Mech Mater* 2008;40:446–52
- Nosbi N, Akil HM, Mohd Ishak ZA, Abu Bakar A. Degradation of compressive properties of pultruded kenaf fiber reinforced composites after immersion in various solutions. *Mater Des* 2010; 31:4960–4.
- Mazuki AAM, Akil HM, Safiee S, Ishak ZAM, Bakar AA. Degradation of dynamic mechanical properties of pultruded kenaf fiber reinforced composites after immersion in various solutions. *Compos Part B: Eng* 2010.
- Doan TTL, Brodowsky H, Mäder E. Jute fiber/polypropylene composites II. Thermal, hydrothermal and dynamic mechanical behaviour. *Compos Sci Technol* 2007;67:2707–14
- Omar MF, Md Akil H, Ahmad ZA, Mazuki AAM, Yokoyama T. Dynamic properties of pultruded natural fiber reinforced composites using Split Hopkinson Pressure Bar technique. *Mater Des* 2010;31:4209–18
- Oksman K, Skrifvars M, Selin JF. Natural fibers as reinforcement in poly lactic acid (PLA) composites. *Compos Sci Technol* 2003;63:1317–24
- G.V.R.Seshagiri Rao, Vadnala Priyanka, V V S H Prasad, Design and Analysis of Automobile Bumper. ISSN: 2278-3075, Volume-9 Issue-1, November 2019
- Dr. R. Ramachandra, Modeling and Static Analysis of Car Bumper. 2017 IJEDR | Volume 5, Issue 4 | ISSN: 2321-9939
- Praveen Kumar.A, Sameer Belagali, Bhaskar .Comparative Study of Automotive Bumper with Different Materials for Passenger and Pedestrian Safety. *OSR Journal of Mechanical and Civil Engineering (IOSR-JMCE)* e-ISSN: 2278-1684,p-ISSN: 2320-334X, Volume 11, Issue 4 Ver. III (Jul- Aug. 2014), PP 60-64.
- Rambhad, Kishor, Venkateshwara, Sonwane, Pradip, Suryawanshi, Shubham,Thigale, Mahesh.A Review on Automotive Bumper Beam Design and Analysis. *Journal of Automotive Engineering &Technology* Volume 5 Issue 1
- S. Nandhakumar, S. Seenivasan, A. Mohammed Saalih, Muhammed Saifudheen, Weight optimization and structural analysis of an electric bus chassis frame, *Materials Today: Proceedings*,Volume 37, Part 2,2021,Pages1824-1827,ISSN 2214-7853,https://doi.org/10.1016/j.matpr.2020.07.404.

