



Implementation of Half Wave Dipole Antenna Design and Parametric Analysis for SAR Measurement

Amol D Sonawane
Research Scholar, AISSMS's Institute of Information and Technology
Pune, India
amolsonawane1431@gmail.com

Dattatraya Bormane
Professor and Principal
AISSMS College of Engineering
Pune, India
bdattatraya@gmail.com

Abstract—

Antenna invention may be the boon for telecommunication field whereas the dipole antenna finds most commonly and widely used transducer in wireless communication devices. In recent years, the rapid change in technology, antenna performance parameters get precisely improved. This paper explains stepwise design procedure of half wave dipole antenna with standard calculations so that one can be easily followed for their new inventions as well intention to design proposed antenna for Specific Absorption Rate (SAR) measurement in human head. The antenna performance parameters such as radiation pattern, VSWR, return loss been evaluated. HFSS simulation software used to design and analyze half wave dipole antenna at 1800 MHz. It proves that the proposed model is efficient version of dipole antenna at given frequency.

4551

Keywords—Half Wave Dipole Antenna; HFSS; Specific Absorption Rate; Return Loss; VSWR; Radiation Pattern.

DOI Number:10.14704/nq.2022.20.8.NQ44483

NeuroQuantology 2022; 20(8): 4551-4557

I. INTRODUCTION

Dipole antenna plays an important role in wireless communications. Half wave dipole antenna length is approximately one half of the wavelength but practically 0.45 times of the wavelength which commonly used in practical RF antenna with various applications. [1] Dipole antenna is center fed driven element which can be made by simple wire to act as a radio antenna. The dipole antenna is constructed by two quarter wavelengths conducting elements to form total wavelength $\lambda/2$ as shown in fig 1.

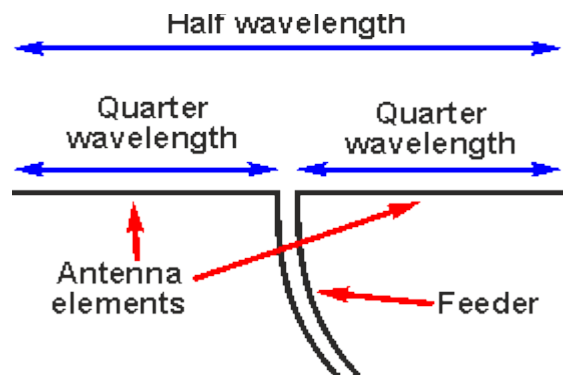

Fig.1. Half Wave dipole center feed.
Basically dipole antenna exhibits two terminals or poles through which RF current flows in association with voltage



which causes radiation of electromagnetic signal from dipole antenna as shown in fig 2.

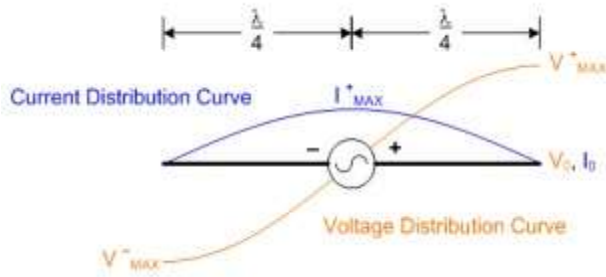

Fig. 2. Voltage and Current distribution in dipole.

The performance of dipole antenna can be measure with the parameters such as radiation pattern, Impedance, gain, VSWR, return loss etc. when dipole antenna installed vertically, it acts as an Omni-directional whereas it acts as a weekly directional when installed horizontally.[2]

The constructional details of the proposed half wave dipole antenna [3] has been shown in fig 3.

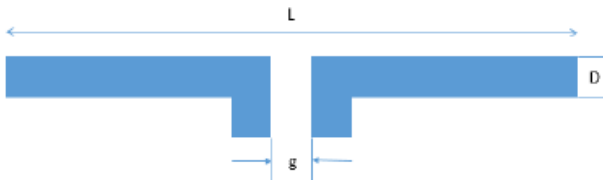

Fig.3. Construction of Half Wave dipole.

Here letter ‘g’ indicates feeding gap which is gap between two arms for center feed purpose, letter ‘D’ indicates thickness and letter ‘L’ shows the total length of the half wave dipole antenna. The standard value of the radiation resistance can be considered for proposed half wave dipole antenna i.e. 73 Ω which matches the line impedance [4].

In this paper, the half wave dipole antenna is designed at operating frequency 1800 MHz to examine the performance parameters radiation pattern, gain, VSWR and return loss. The proposed half wave dipole antenna can be further used to investigate SAR in human head by measuring the amount of radiation penetrated by EM waves originated from antenna which acts as a mobile phone.

II. DESIGN PARAMETERS

The Important design parameter of half wave dipole antenna is resonant frequency, on which dimensions of an antenna mainly depends and changes accordingly. The design proposed frequency 1.8 GHz, based on this total length (L) of the antenna, Wavelength (λ), radius of the dipole or thickness (D) and feeding gap (g) can be calculated.[5]

Resonant frequency (f_r),

$$f_r = 1.8 \text{ GHz.}$$

Wavelength (λ) of half wave dipole antenna,

$$\lambda = c/f$$

$$\lambda = (3 \times 10^8) / (1.8 \times 10^9)$$

$$\lambda = 167 \text{ mm} \tag{1}$$

Dipole Length (L) of half wave dipole antenna,

$$L = 143/f$$

$$L = 79.44 \text{ mm} \tag{2}$$

Arm Length of half wave dipole antenna,

$$L_{\text{arm}} = L/2$$

$$L_{\text{arm}} = 79.44/2$$

$$L_{\text{arm}} = 39.72 \text{ mm} \tag{3}$$

Dipole Radius (R) of half wave dipole antenna,

$$R = \lambda/1000$$

$$R = 167/1000$$

$$R = 0.167 \text{ mm} \tag{4}$$

Feeding Gap (g) of half wave dipole antenna,

$$g = L/200$$

$$g = 79.44/200$$

$$g = 0.3972 \text{ mm} \tag{5}$$

Theoretically, Gain (G) of half wave dipole antenna, can be calculated by following formula as in [6]

i.e.

$$G = 60^2/30R \tag{6}$$

First equation shows the value of wavelength, second equation shows the value of length of the half wave dipole antenna. The value of radius and feeding gap found from equation number 4 and 5 respectively. The summary of all dimensions of proposed half wave dipole antenna is given in Table 1.

TABLE I. DESIGN PARAMETERS OF HALF WAVE DIPOLE ANTENNA

Parameter	Value	Unit
Resonant Frequency (f _r)	1.8	GHz
Wavelength (λ)	167	mm
Length of the dipole (L)	79.44	mm
Dipole Arm (L/2)	39.72	mm
Gap (g)	0.3972	mm
Radius of the dipole (R)	0.167	mm
Maching Impedance (Z ₀)	73	Ohm



III. ANTENNA SIMULATION METHODOLOGY

According to the design parameters shown in Table 1, a half-wave dipole antenna has been designed using simulation software. There is many simulation software are available, one can use HFSS or CST MWS for investigation of performance parameters of half wave dipole antenna.

The fig. 4 shows flow chart useful for getting simulation of proposed antenna using HFSS software.

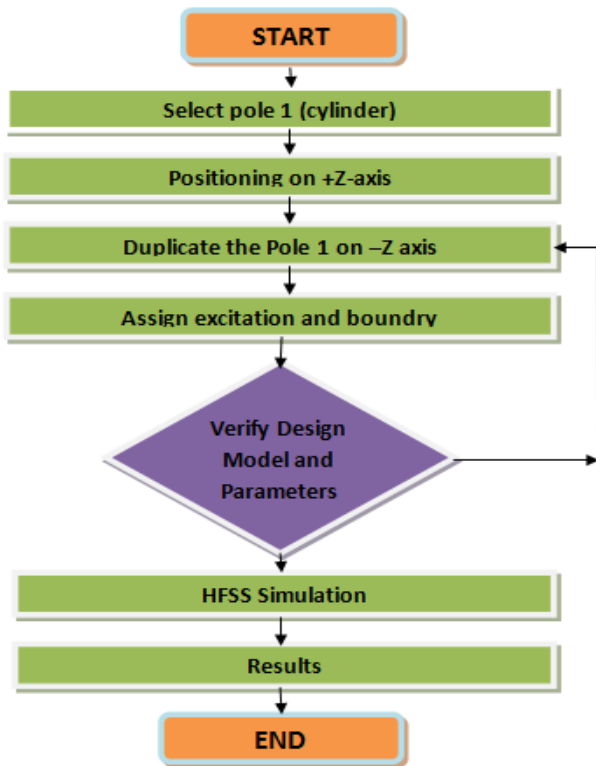

Fig.4. Half Wave Dipole Design Flow Chart

The half wave dipole antenna can be simulated using steps given in flowchart with calculated geometric dimensions as per Table 1, the proposed dipole antenna simulated using HFSS as shown in Fig.5.

Once GUI of HFSS completely opened, select for “Insert HFSS design” for half wave dipole antenna design, the reason is whenever design belongs to electric and magnetic field, it must be with HFSS design but design is only with electrical field choose “Insert HFSS IE Design”. After selecting new project, user can see change in modular window as shown if Fig. 5.

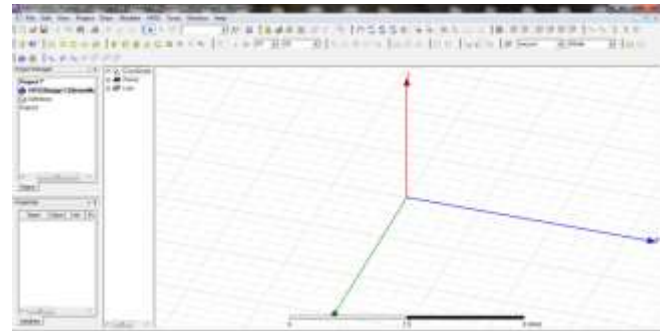

Fig.5. GUI of HFSS software

Firstly select cylinder shape for dipole arm, assign calculated values in property window accordingly pole1 of dipole appeared as shown in Fig.6.

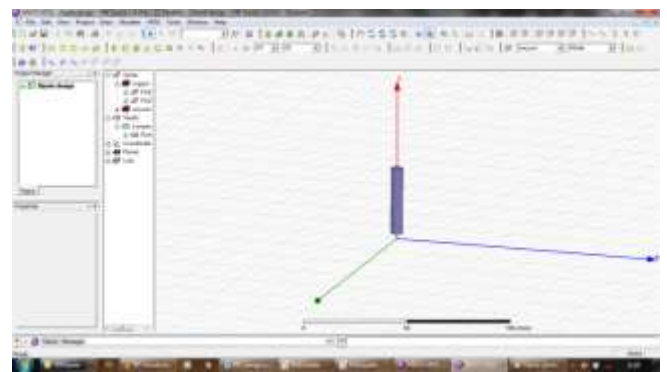

Fig.6. Pole1 of HW Dipole

As per the fourth step shown in flow chart Fig. 4, duplicate pole1 so that two poles can be observed in design as shown in Fig.7. the main advantage of duplicating pole is, whenever we make changes in pole1, pole2 automatically changes with equal dimensions.

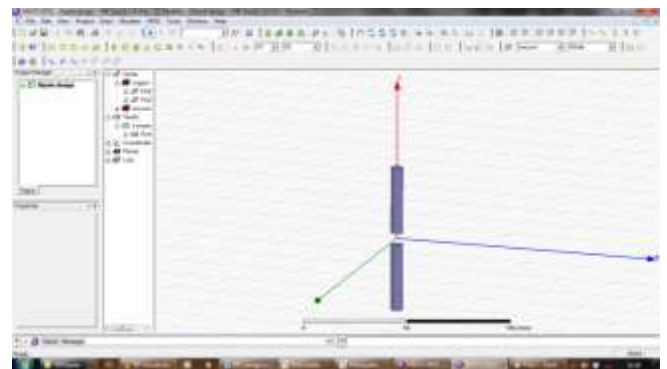

Fig.7. Pole1 and Pole2 of HW Dipole.

Now there is need to form feeding port between pole1 and pole2, also excitation must be done for feeding port or lumped port as shown in Fig. 8.



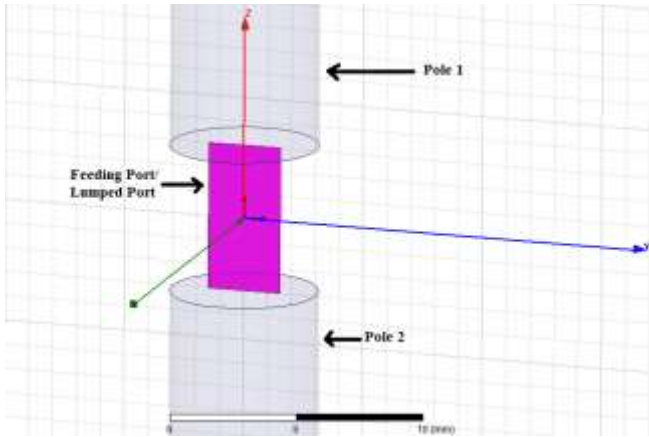

Fig.8. Feeding port or Lumped port

The antenna can be look complete half wave dipole in modular window as shown in Fig. 9.

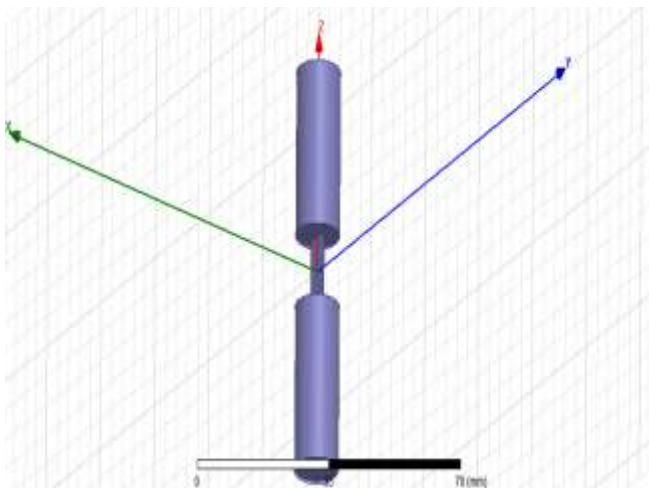

Fig.9. Designed Half Wave Dipole Antenna

Now it's time to assign boundary with box for designed half wave dipole antenna and form radiation boundary as shown in Fig. 10, then create analysis setup to assign center frequency and frequency sweep.

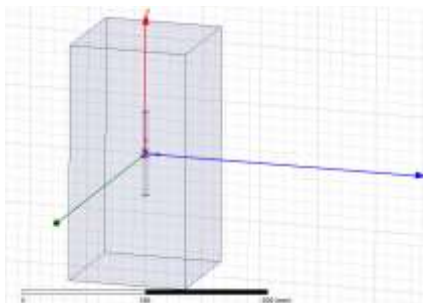

Fig.10. Radiation Boundary

To verify whether proposed antenna correctly and completely designed, validate our design with validate tab in toolbar of HFSS. Validate window popup will appear so that

one can correct error as if otherwise following window popup appears to confirmed that all is well designed as shown in Fig. 11.

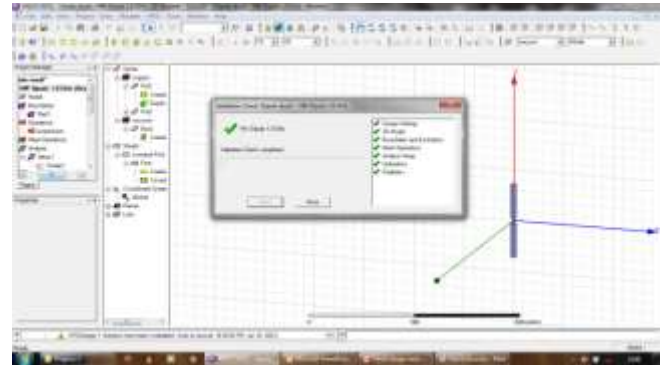

Fig.11. Validate Proposed Design.

IV. SIMULATION RESULTS AND DISCUSSION

The proposed half wave dipole antenna designed with copper material at 1800 MHz frequency. To examine the performance parameters, simulation results must be observed

A. Return Loss/ S11 parameters (dB):

Return loss indicates the proportion of radio waves arrives at the input port of an antenna which are rejected from output port with a ratio against those radio waves are accepted. Return loss is an important characteristic which shows performance of antenna which can be written as follow;

$$R = 10 \log_{10} \left(\frac{P_i}{P_r} \right) \quad (7)$$

Where R indicates return loss, P_i indicates input power and P_r shows return power from output port.

After the simulation, the return loss plot of proposed half wave dipole antenna been shown in Fig. 12.

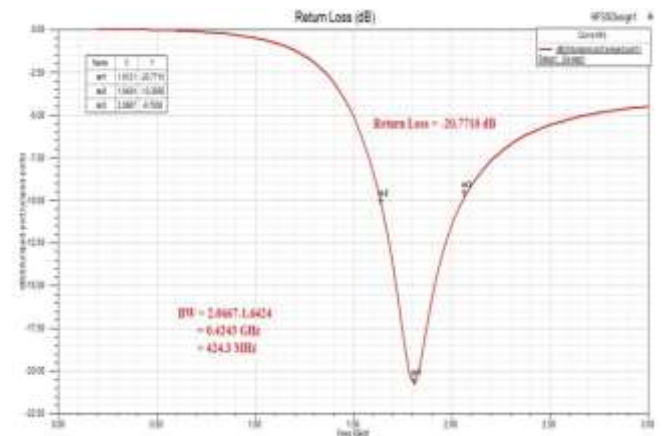

Fig.12. Return Loss curve and Bandwidth for designed half wave dipole antenna.



From the Fig.12, it may be observed that return loss for proposed half wave dipole antenna is -20.7710 dB shown by marker m1 at sharp deep curve. The bandwidth of proposed design found as 424.3 MHz, calculated by difference between higher and lower cut off frequencies at -10 dB shown by marker m3 and m2 are 2066.7 MHz and 1642.4 MHz respectively as mentioned in Fig.12. In the result window of return loss, one can see single deep curve which shows proposed designed half wave dipole antenna being single band antenna, whereas if it could show two deep curve then its dual band antenna.

B. Voltage Standing Wave Ratio(VSWR in dB):

The voltage standing wave ratio is important characteristics of proposed design as it is a function of the reflection coefficient (Γ), which describes the power reflected from the antenna. The formula of VSWR can be written as follows:

$$VSWR = \frac{1+|\Gamma|}{1-|\Gamma|} \quad (8)$$

After simulation of proposed half wave antenna design for VSWR parameter, author found the value of VSWR 1.5901 dB shown in Fig.13.

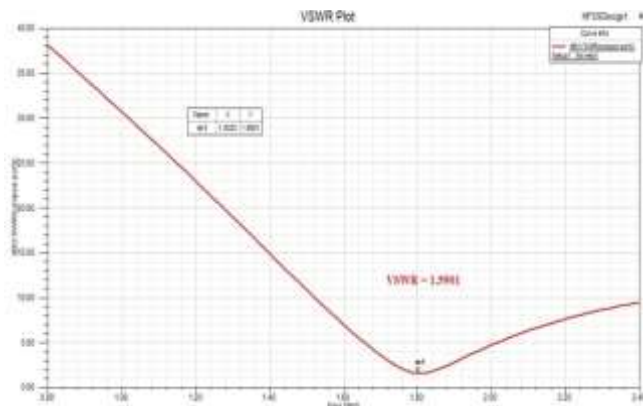

Fig.13. VSWR Plot for designed half wave dipole antenna.

VSWR is positive figure, lesser value of VSWR shows better impedance matching so that maximum power can be delivered. The minimum value of VSWR must be 1 and it possible when reflection coefficient becomes zero.

C. Radiation Pattern and Gain:

The radiation pattern is the graphical representation of power radiated by an antenna which is function of angular direction away from the antenna. It can be shown by 2D/3D pattern. The 2D plot of proposed half wave dipole antenna shown by Fig.14 and 3D radiation pattern plot for the same antenna is shown by Fig.15.

The radiation pattern in Fig.16, red color indicates higher gain while green color shows lower gain of an half wave dipole antenna. Higher gain may be obtained far from an

antenna circularly but upper side and lower side of an antenna provides lower gain.

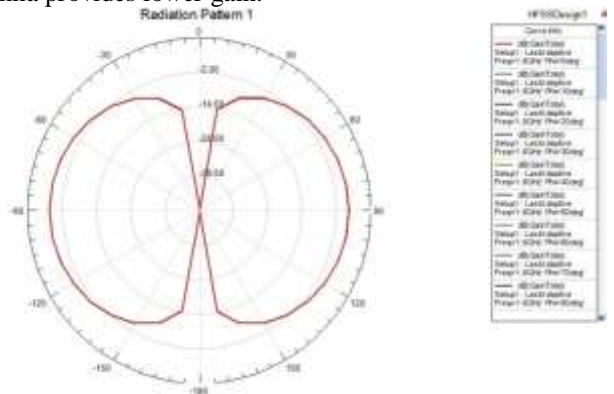
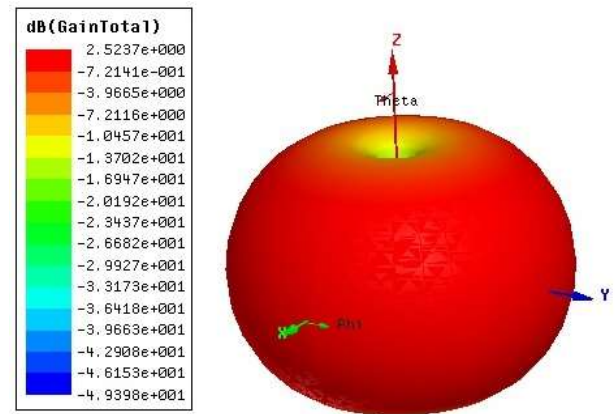

Fig.14. 2D Radiation Pattern for designed half wave dipole antenna.

The direction of maximum radiation shown in 2D radiation pattern by Fig.14 at +90 degree and -90 degree theta, consequently the minimum radiation at 0 and -180 degree.



4555

Fig.15. 3D Radiation Pattern for designed half wave dipole antenna.

The directivity obtained with proposed half wave dipole antenna is almost identical to the theoretical ones. [7]

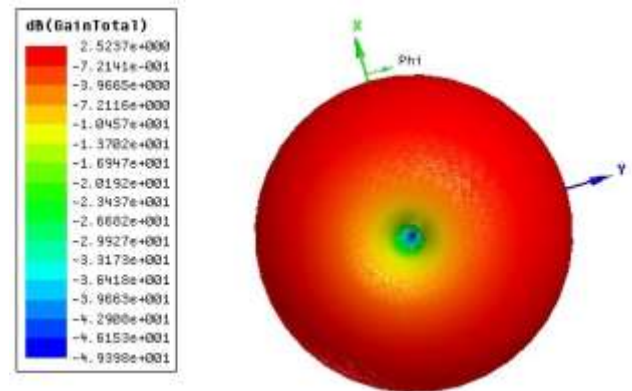

Fig.16. 3D Radiation Pattern shows gain variation.



The 3D radiation pattern of speaks more about detailing of gain in all direction as compare to 2D radiation pattern.

The summery of all performance parameters author have examine such as return loss, voltage standing wave ratio, gain, bandwidth of designed half wave dipole antenna tabulated in Table II.

TABLE II.SIMULATED RESULTS OF DESIGNED HALF WAVE DIPOLE ANTENNA

Parameter	Value	Unit
Return Loss	-20.7710	dB
VSWR	1.5901	dB
Gain	2.5237	dB
Bandwidth	424.3	MHz

Few more important parameters of proposed antenna tabulated in Table III, which may used as per the requirement for the analysis.

TABLE III.ADDITIONAL PARAMETERS OF DESIGNED HALF WAVE DIPOLE ANTENNA

4556

The proposed antenna designed and analyzed for specific absorption rate (SAR) measurement in human head at 1800 MHz frequency.

At present, still the debate about the higher absorption of EM energy by children is not resolve. No significant evidences are came in our survey which can bring out mankind from dilemma of weather human child absorbs less or more energy than adults.[10] It is always helpful to measure SAR in human head to avoid confusion and save mankind if harmful.

Therefore, SAR is the measure of the rate at which RF energy is absorbed by body when exposed to electromagnetic field [10]. It can be defined as power absorbed by tissue per unit mass of the tissue. Its unit is watt per kilogram (W/kg).

$$SAR = \sigma|E|^2/2\rho \tag{9}$$

In equation no 1, the sigma (σ) indicates the electrical conductivity in Siemens per meter, where E is an electric field strength measured in volt per meter and the rho (ρ) is



the mass density measured in kilogram per cubic meter. Some researchers [11] reported some standard values of SAR limit time to time through ICNIRP [7], FCC [9] and IEEE [8] standards.

V. CONCLUSIONS

A half-wave dipole antenna has been designed and simulated using HFSS software. A popular practical antenna half-wave dipole was selected to obtain target frequency 1.8 GHz for mobile phone specifically to measure SAR in human head.

After simulation of proposed half wave antenna design for VSWR parameter, author found the value of VSWR 1.5901 dB which shows less than two, Return loss obtained as -20.7710 dB which shows the characteristic of reflection coefficient. It provides appreciable bandwidth approximately 21% of resonant frequency. The high gain obtained at 2.5237 dB. The directivity obtained with proposed half wave dipole antenna is almost identical to the theoretical ones. Still there may be scope to improve result by working on few parameters. Proposed study may also be helpful to new researchers those willing to work in wireless communication field.

In future, work can be carried out to justify EM radiations from wireless devices specifically mobile phones may or may not be harmful to human being. Still there may be scope to investigate the SAR in human head. In many studies, SAR is calculated superficially, so consideration of detailed electrical properties of skin, ear, nose, bone and skull are needed while SAR analysis is held. Development of a resistive sheet for mobile handset will be a better safety measure in future.

REFERENCES

- [1] Balanis, Constantine A., "Antenna Theory Analysis and Design", John Wiley & Sons, 3rd Edition, USA (2005), pg.151.
- [2] Ramo, Simon, Whinnery, John R., Duzer, Theodore Van, "Fields and Waves in Communication Electronics", John Wiley & Sons, 3rd Edition, Canada(1994).
- [3] Saunders, Simon R., Zavala, Alejandro Aragon, "Antennas and Propagation for Wireless Communication Systems", John Wiley & Sons, 2nd Edition, England (2007), pg.73.
- [4] Balanis, Constantine A., "Antenna Theory Analysis and Design", John Wiley & Sons, 3rd Edition, USA (2005), pg.182.
- [5] Parminder Singh, Ankita Sharma, Neha Uniyal, Richa Kala, "Half-Wave Dipole Antenna for GSM Applications", International Journal of Advanced Computer Research (ISSN (print): 2249-7277 ISSN (online): 2277-7970), Volume-2 Number-4 Issue-6 December-2012.
- [6] Balanis, Constantine A., "Antenna Theory Analysis and Design", John Wiley & Sons, 3rd Edition, USA (2005), pg.34-35.

[7] ICNIRP Guidelines, "Guidelines for limiting exposure to time-varying electric, magnetic, and electromagnetic fields (up to 300 GHz)," Health Phys., vol. 74, no. 4, pp. 494–522, Apr. 1998.

[8] IEEE Standard for Safety Levels with Respect to Human Exposure to Radio Frequency Electromagnetic Fields, 3 kHz to 300 GHz, IEEE Standard C95.1, 2005.

[9] FCC-Federal Communications Committee, office of Engineering and Technology, Evaluating compliance with FCC guidelines for human exposure to Radiofrequency Electromagnetic Fields, additional information for evaluating compliance of mobile and portable devices with FCC limits for human exposure to radiofrequency Emissions, Supplement C (Edition 01-01) to OET bulletin 65 (Edition 95-01), June 2001.

[10] Amol D Sonawane & Dattatraya S Bormane, "A Specific Absorption Rate in Human due to Mobile Phone Radiations: Review" 2020 International Conference on Electronics and Sustainable Communication Systems (ICESC), IEEE Xplore Part Number:CFP20V66-ART; ISBN:978-1-7281-4108-4, August 2020.

[11] Claudio Enrique Fernandes-Rodriguez, Alvaro Augusto Almeida de Salles, Devra Lee Devis, "Dosimetric simulation of brain absorption of mobile phone radiation-the relationship between psSAR and age " 2169-3536 © 2015 IEEE.

